

**800-535-SWIM**  
**SanJuanPools.com**

**San Juan Fiberglass Pool & Spa Models**

## San Juan Fiberglass Pools' Color Selection

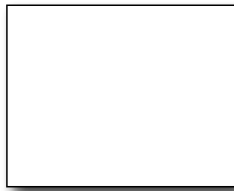

White



Sully Blue

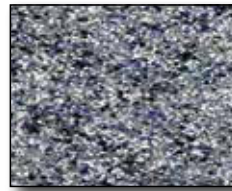

Granite

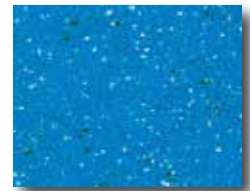

Blue Lagoon

<p><b>Luxor Deep</b></p>  <p>Width: ..... I.D. 15' 1" / O.D. 16'            Length: ..... I.D. 44' 3" / O.D. 45' 3"            Depth: ..... 3' 8" - 7' 10"            Area ..... 667.4 ft<sup>2</sup>            Volume: ..... 22,676 G</p>	<p><b>Luxor</b></p>  <p>Width: ..... I.D. 15' 1" / O.D. 16'            Length: ..... I.D. 44' 3" / O.D. 44' 7"            Depth: ..... 3' 8" - 6' 4"            Area ..... 667.4 ft<sup>2</sup>            Volume: ..... 21,210 G</p>	<p><b>Oceanside Beach</b></p>  <p>Width: ..... I.D. 15' 2" / O.D. 16'            Length: ..... I.D. 44' 8" / O.D. 45' 8"            Depth: ..... 3' 7" - 6' 5"            Area ..... 670 ft<sup>2</sup>            Volume: ..... 21,250 G</p>	<p><b>Great Lakes Beach</b></p>  <p>Width: ..... I.D. 15' 1" / O.D. 15' 11"            Length: ..... I.D. 40' 3" / O.D. 41' 3"            Depth: ..... 3' 11" - 6' 4"            Area ..... 607.6 ft<sup>2</sup>            Volume: ..... 18,761 G</p>
<p><b>Oceanside</b></p>  <p>Width: ..... I.D. 15' 2" / O.D. 16'            Length: ..... I.D. 40' 2" / O.D. 41' 2"            Depth: ..... 3' 7" - 6' 5"            Area ..... 609.3 ft<sup>2</sup>            Volume: ..... 20,400 G</p>	<p><b>Pacific</b></p>  <p>Width: ..... I.D. 15' 1" / O.D. 16'            Length: ..... I.D. 38' 10" / O.D. 39' 10"            Depth: ..... 3' 3" - 7' 11"            Area ..... 569.2 ft<sup>2</sup>            Volume: ..... 21,609 G</p>	<p><b>Dallas</b></p>  <p>Width: ..... I.D. 15' 1" / O.D. 16'            Length: ..... I.D. 41' 4" / O.D. 42' 4"            Depth: ..... 3' 3" - 7' 11"            Area ..... 595 ft<sup>2</sup>            Volume: ..... 21,000 G</p>	<p><b>Great Lakes</b></p>  <p>Width: ..... I.D. 15' 1" / O.D. 15' 11"            Length: ..... I.D. 36' / O.D. 36' 11"            Depth: ..... 3' 6" - 6' 4"            Area ..... 543 ft<sup>2</sup>            Volume: ..... 18,653 G</p>
<p><b>Olympus</b></p>  <p>Width: ..... I.D. 15' 2" / O.D. 16'            Length: ..... I.D. 38' 11" / O.D. 39' 11"            Depth: ..... 3' 6" - 5' 4"            Area ..... 540 ft<sup>2</sup>            Volume: ..... 13,334 G</p>	<p><b>Phoenix</b></p>  <p>Width: ..... I.D. 15' / O.D. 16'            Length: ..... I.D. 38' 10" / O.D. 39' 10"            Depth: ..... 3' 4" - 5'            Area ..... 539 ft<sup>2</sup>            Volume: ..... 14,452 G</p>	<p><b>Caesar's Palace Beach</b></p>  <p>Width: ..... I.D. 14' 9" / O.D. 15' 8"            Length: ..... I.D. 35' 2" / O.D. 36'            Depth: ..... 3' 7" - 5' 7"            Area ..... 520.5 ft<sup>2</sup>            Volume: ..... 12,057 G</p>	<p><b>Wylela Beach Ultra</b></p>  <p>Width: ..... I.D. 15' / O.D. 16'            Length: ..... I.D. 36' 1" / O.D. 37'            Depth: ..... 3' 6" - 6' 1"            Area ..... 540 ft<sup>2</sup>            Volume: ..... 14,375 G</p>
<p><b>Wylela Cove Ultra</b></p>  <p>Width: ..... I.D. 15' / O.D. 16'            Length: ..... I.D. 36' 1" / O.D. 37'            Depth: ..... 3' 6" - 6' 1"            Area ..... 540 ft<sup>2</sup>            Volume: ..... 15,321 G</p>	<p><b>Lake Superior</b></p>  <p>Width: ..... I.D. 15' 1" / O.D. 15' 10"            Length: ..... I.D. 29' 11" / O.D. 30' 9"            Depth: ..... 3' 11" - 6' 3"            Area ..... 441 ft<sup>2</sup>            Volume: ..... 14,601 G</p>	<p><b>Niagara</b></p>  <p>Width: ..... I.D. 14' 11" / O.D. 15' 11"            Length: ..... I.D. 32' 10" / O.D. 33' 10"            Depth: ..... 3' 8" - 7' 10"            Area ..... 489.76 ft<sup>2</sup>            Volume: ..... 17,600 G</p>	<p><b>Caesar's Palace</b></p>  <p>Width: ..... I.D. 14' 9" / O.D. 15' 8"            Length: ..... I.D. 32' 5" / O.D. 33' 4"            Depth: ..... 3' 3" - 5' 7"            Area ..... 421.51 ft<sup>2</sup>            Volume: ..... 11,727 G</p>

Coming Soon

### Grand Manhattan



Width: ..... I.D. 14'6" / O.D. 15'6"  
 Length: ..... I.D. 32'10" / I.D. 33'10"  
 Depth: ..... 3'11" - 4'11"  
 Area ..... 476 ft<sup>2</sup>  
 Volume: ..... 12,528 G

### Monte Carlo



Width: ..... I.D. 15'1" / O.D. 15'11"  
 Length: ..... I.D. 30'11" / I.D. 31'10"  
 Depth: ..... 3'7" - 5'8"  
 Area ..... 466.19 ft<sup>2</sup>  
 Volume: ..... 13,101 G

### Wylela Beach Grande



Width: ..... I.D. 15' / O.D. 16'  
 Length: ..... I.D. 29'1" / O.D. 30'  
 Depth: ..... 3'6" - 6'1"  
 Area ..... 435 ft<sup>2</sup>  
 Volume: ..... 10,789 G

### Majestic



Width: ..... I.D. 15'2" / O.D. 16'  
 Length: ..... I.D. 33'1" / O.D. 34'1"  
 Depth: ..... 3'6" - 5'5"  
 Area ..... 446.46 ft<sup>2</sup>  
 Volume: ..... 12,531 G

### Wylela Cove Grande

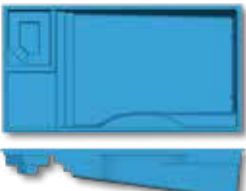

Width: ..... I.D. 15' / O.D. 16'  
 Length: ..... I.D. 29' / O.D. 30'  
 Depth: ..... 3'6" - 6'1"  
 Area ..... 435 ft<sup>2</sup>  
 Volume: ..... 11,134 G

### Dolphin



Width: ..... I.D. 13'1" / O.D. 14'1"  
 Length: ..... I.D. 32'1" / O.D. 33'1"  
 Depth: ..... 4' - 5'  
 Area ..... 402 ft<sup>2</sup>  
 Volume: ..... 11,000 G

### Savannah



Width: ..... I.D. 13'3" / O.D. 14'3"  
 Length: ..... I.D. 31'7" / O.D. 32'7"  
 Depth: ..... 3'3" - 5'4"  
 Area ..... 375 ft<sup>2</sup>  
 Volume: ..... 10,500 G

### Lake Michigan

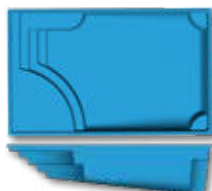

Width: ..... I.D. 15' / O.D. 15'11"  
 Length: ..... I.D. 24'11" / O.D. 25'11"  
 Depth: ..... 3'11" - 5'11"  
 Area ..... 373.75 ft<sup>2</sup>  
 Volume: ..... 10,714 G

### Vegas



Width: ..... I.D. 14'11" / O.D. 15'9"  
 Length: ..... I.D. 26'11" / O.D. 27'11"  
 Depth: ..... 3'2" - 5'  
 Area ..... 359 ft<sup>2</sup>  
 Volume: ..... 9,420 G

### iPool



Width: ..... I.D. 15' / O.D. 16'  
 Length: ..... I.D. 35'1" / O.D. 36'  
 Depth: ..... 4'7"  
 Area ..... 348 ft<sup>2</sup>  
 Volume: ..... 7,217 G

### Stockholm



Width: ..... I.D. 13' / O.D. 14'  
 Length: ..... I.D. 26'1" / O.D. 27'1"  
 Depth: ..... 3'9" - 5'9"  
 Area ..... 339.08 ft<sup>2</sup>  
 Volume: ..... 9,600 G

### Hawaiian



Width: ..... I.D. 11'9" / O.D. 12'9"  
 Length: ..... I.D. 27'11" / O.D. 29'  
 Depth: ..... 3'4" - 5'10"  
 Area ..... 303.09 ft<sup>2</sup>  
 Volume: ..... 8,375 G

### Wylela Beach

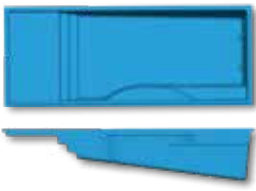

Width: ..... I.D. 11' / O.D. 12'  
 Length: ..... I.D. 29'1" / O.D. 30'  
 Depth: ..... 3'6" - 6'1"  
 Area ..... 319 ft<sup>2</sup>  
 Volume: ..... 7,587 G

### Wylela Cove

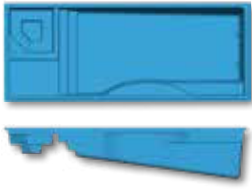

Width: ..... I.D. 11' / O.D. 12'  
 Length: ..... I.D. 29'1" / O.D. 30'  
 Depth: ..... 3'6" - 6'  
 Area ..... 319 ft<sup>2</sup>  
 Volume: ..... 7,832 G

### Biloxi Beach



Width: ..... I.D. 11' / O.D. 12'  
 Length: ..... I.D. 26' / O.D. 27'  
 Depth: ..... 4'3"  
 Area ..... 286 ft<sup>2</sup>  
 Volume: ..... 6,800 G

### Marathon w/spa



Width: ..... I.D. 7'6" / O.D. 8'6"  
 Length: ..... I.D. 39' / O.D. 40'1"  
 Depth: ..... 4'9"  
 Area ..... 292.5 ft<sup>2</sup>  
 Volume: ..... 8,277 G

### Marathon



Width: ..... I.D. 7'6" / O.D. 8'6"  
 Length: ..... I.D. 33' / O.D. 34'2"  
 Depth: ..... 4'9"  
 Area ..... 248 ft<sup>2</sup>  
 Volume: ..... 7,507 G

### Orlando

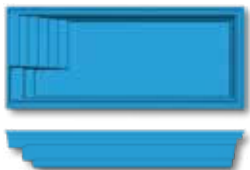

Width: ..... I.D. 11' / O.D. 12'  
 Length: ..... I.D. 27' / O.D. 28'  
 Depth: ..... 3'10"  
 Area ..... 297 ft<sup>2</sup>  
 Volume: ..... 7,000 G

### Waikiki II



Width: ..... I.D. 10'10" / O.D. 11'10"  
 Length: ..... I.D. 27' / O.D. 28'  
 Depth: ..... 3'7" - 5'5"  
 Area ..... 275 ft<sup>2</sup>  
 Volume: ..... 8,010 G













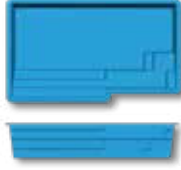

### Waikiki I

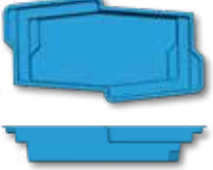

Width: ..... I.D. 11'2" / O.D. 12'2"  
 Length: ..... I.D. 25'11" / O.D. 26'11"  
 Depth: ..... 3'8" - 5'5"  
 Area ..... 268 ft<sup>2</sup>  
 Volume: ..... 8,059 G

\* Additional cross-country freight

# San Juan Fiberglass Pool & Spa Models

<p><b>iPool 2</b></p>  <p>Width: ..... I.D. 12'1" / O.D. 13'1"            Length: ..... I.D. 24'9" / O.D. 25'9"            Depth: ..... 3'10" - 4'8"            Area ..... 264 ft<sup>2</sup>            Volume: ..... 6,700 G</p>	<p><b>Wylela</b></p>  <p>Width: ..... I.D. 11' / O.D. 12'            Length: ..... I.D. 24'1" / O.D. 25'            Depth: ..... 3'6" - 6'1"            Area ..... 256.2 ft<sup>2</sup>            Volume: ..... 7,315 G</p>	<p><b>Scottsdale</b></p>  <p>Width: ..... I.D. 10'8" / O.D. 11'8"            Length: ..... I.D. 18'6" / O.D. 19'6"            Depth: ..... 4'            Area ..... 187.7 ft<sup>2</sup>            Volume: ..... 7,070 G</p> <p style="writing-mode: vertical-rl; transform: rotate(180deg);">* West Coast Factory Only</p>	<p><b>Canyon Beach Grande</b></p>  <p>Width: ..... I.D. 8'4" / O.D. 9'6"            Length: ..... I.D. 28'5" / O.D. 30'            Depth: ..... 5'            Area ..... 236.8 ft<sup>2</sup>            Volume: ..... 6,586 G</p> <p style="writing-mode: vertical-rl; transform: rotate(180deg);">* West Coast Factory Only</p>
<p><b>Broadway</b></p>  <p>Width: ..... I.D. 10'9" / O.D. 11'8"            Length: ..... I.D. 20'8" / O.D. 21'8"            Depth: ..... 4'            Area ..... 222.16 ft<sup>2</sup>            Volume: ..... 4,887 G</p>	<p><b>Horizon</b></p>  <p>Width: ..... I.D. 14'8" / O.D. 15'8"            Length: ..... I.D. 23'2" / O.D. 24'2"            Depth: ..... 4'9"            Area ..... 220 ft<sup>2</sup>            Volume: ..... 6,000 G</p>	<p><b>Gulf Breeze</b></p>  <p>Width: ..... I.D. 11' / O.D. 12'            Length: ..... I.D. 19' / O.D. 20'            Depth: ..... 3'10"            Area ..... 209 ft<sup>2</sup>            Volume: ..... 4,400 G</p>	<p><b>Malibu</b></p>  <p>Width: ..... I.D. 11'1" / O.D. 12'1"            Length: ..... I.D. 21'4" / O.D. 22'4"            Depth: ..... 3'9"            Area ..... 185 ft<sup>2</sup>            Volume: ..... 4,061 G</p>
<p><b>Sea Isle</b></p>  <p>Width: ..... I.D. 11' / O.D. 11'11"            Length: ..... I.D. 15'7" / O.D. 16'6"            Depth: ..... 5'            Area ..... 171.41 ft<sup>2</sup>            Volume: ..... 5,074 G</p>	<p><b>Canyon Beach</b></p>  <p>Width: ..... I.D. 8'4" / O.D. 9'6"            Length: ..... I.D. 20' / O.D. 22'            Depth: ..... 4'            Area ..... 169.4 ft<sup>2</sup>            Volume: ..... 2,700 G</p> <p style="writing-mode: vertical-rl; transform: rotate(180deg);">* West Coast Factory Only</p>	<p><b>Cyberlane w/spa</b></p>  <p>Width: ..... I.D. 7'5" / O.D. 8'5"            Length: ..... I.D. 22' / O.D. 23'            Depth: ..... 4'9"            Area ..... 163.16 ft<sup>2</sup>            Volume: ..... 4,350 G</p>	<p><b>Cyberlane</b></p>  <p>Width: ..... I.D. 7'5" / O.D. 8'5"            Length: ..... I.D. 16' / O.D. 16'8"            Depth: ..... 4'9"            Area ..... 120 ft<sup>2</sup>            Volume: ..... 3,491 G</p>
<p><b>Canyon Lake</b></p>  <p>Width: ..... I.D. 8'4" / O.D. 10'2"            Length: ..... I.D. 15'8" / O.D. 18'11"            Depth: ..... 4'            Area ..... 130.55 ft<sup>2</sup>            Volume: ..... 3,308 G</p> <p style="writing-mode: vertical-rl; transform: rotate(180deg);">* West Coast Factory Only</p>	<p><b>Sedona Beach</b></p>  <p>Width: ..... I.D. 6'4" / O.D. 7'10"            Length: ..... I.D. 18'5" / O.D. 20'            Depth: ..... 5'            Area ..... 133 ft<sup>2</sup>            Volume: ..... 2,607 G</p> <p style="writing-mode: vertical-rl; transform: rotate(180deg);">* West Coast Factory Only</p>	<p><b>Sedona</b></p>  <p>Width: ..... I.D. 6'4" / O.D. 8'4"            Length: ..... I.D. 12'4" / O.D. 14'6"            Depth: ..... 3'5"            Area ..... 78.11 ft<sup>2</sup>            Volume: ..... 1,813 G</p>	<p><b>Daytona Beach</b></p>  <p>Width: ..... I.D. 14'10" / O.D. 15'10"            Length: ..... I.D. 43'11" / O.D. 44'11"            Depth: ..... 3'11" - 7'11"            Area ..... 558.53 ft<sup>2</sup>            Volume: ..... 19,440 G</p>

Check Out Our 3D Interactive Pool Drawings

<https://sanjuanpools.com/3d-models>



Scan Me

### South Beach

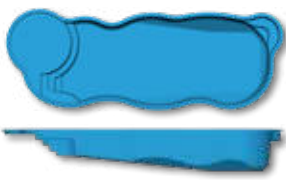

Width: ..... I.D. 14' 10" / O.D. 15' 10"  
 Length: ..... I.D. 43' 11" / O.D. 44' 11"  
 Depth: ..... 3' 11" - 6' 4"  
 Area ..... 563 ft<sup>2</sup>  
 Volume: ..... 17,741 G

### Oasis



Width: ..... I.D. 15' / O.D. 16'  
 Length: ..... I.D. 38' 8" / O.D. 39' 8"  
 Depth: ..... 3' 3" - 7' 11"  
 Area ..... 506 ft<sup>2</sup>  
 Volume: ..... 19,275 G

### Mirage



Width: ..... I.D. 14' 8" / O.D. 15' 7"  
 Length: ..... I.D. 38' 8" / O.D. 39' 5"  
 Depth: ..... 3' 4" - 5' 3"  
 Area ..... 468 ft<sup>2</sup>  
 Volume: ..... 13,776 G

### Clearwater Beach



Width: ..... I.D. 15' 1" / O.D. 15' 11"  
 Length: ..... I.D. 35' 10" / O.D. 36' 9"  
 Depth: ..... 3' 11" - 6' 3"  
 Area ..... 456 ft<sup>2</sup>  
 Volume: ..... 13,387 G

### Star Dust



Width: ..... I.D. 15' / O.D. 16'  
 Length: ..... I.D. 36' 4" / O.D. 37' 4"  
 Depth: ..... 3' 6" - 6' 4"  
 Area ..... 455.96 ft<sup>2</sup>  
 Volume: ..... 14,357 G

### Pleasure Island



Width: ..... I.D. 15' / O.D. 16'  
 Length: ..... I.D. 37' 11" / O.D. 38' 6"  
 Depth: ..... 3' 11" - 5' 11"  
 Area ..... 453.04 ft<sup>2</sup>  
 Volume: ..... 12,828 G

### Atlantic Deep



Width: ..... I.D. 14' 9" / O.D. 15' 9"  
 Length: ..... I.D. 31' 10" / O.D. 33'  
 Depth: ..... 3' 6" - 7' 9"  
 Area ..... 383 ft<sup>2</sup>  
 Volume: ..... 13,772 G

### Atlantic



Width: ..... I.D. 14' 9" / O.D. 15' 9"  
 Length: ..... I.D. 31' 10" / O.D. 33'  
 Depth: ..... 3' 9" - 5' 7"  
 Area ..... 383 ft<sup>2</sup>  
 Volume: ..... 10,883 G

### Manatee Deep



Width: ..... I.D. 12' 9" / O.D. 13' 9"  
 Length: ..... I.D. 31' 10" / O.D. 32' 10"  
 Depth: ..... 3' 6" - 8'  
 Area ..... 369 ft<sup>2</sup>  
 Volume: ..... 14,520 G

\*West Coast Factory Only

### Manatee



Width: ..... I.D. 12' 9" / O.D. 13' 9"  
 Length: ..... I.D. 31' 10" / O.D. 32' 10"  
 Depth: ..... 3' 6" - 5' 10"  
 Area ..... 369 ft<sup>2</sup>  
 Volume: ..... 11,222 G

### Costa Azul



Width: ..... I.D. 14' / O.D. 14' 11"  
 Length: ..... I.D. 31' 8" / O.D. 32' 7"  
 Depth: ..... 3' 8" - 5' 5"  
 Area ..... 350.15 ft<sup>2</sup>  
 Volume: ..... 9,249 G

### Rio



Width: ..... I.D. 14' 10" / O.D. 15' 10"  
 Length: ..... I.D. 27' 4" / O.D. 28' 4"  
 Depth: ..... 3' 6" - 5' 7"  
 Area ..... 326 ft<sup>2</sup>  
 Volume: ..... 9,500 G

### Huntington Beach



Width: ..... I.D. 14' 10" / O.D. 15' 10"  
 Length: ..... I.D. 27' 4" / O.D. 28' 4"  
 Depth: ..... 4' - 5' 7"  
 Area ..... 326 ft<sup>2</sup>  
 Volume: ..... 8,154 G

### Barcelona



Width: ..... I.D. 14' 10" / O.D. 15' 10"  
 Length: ..... I.D. 27' 4" / O.D. 28' 4"  
 Depth: ..... 3' 6" - 5' 7"  
 Area ..... 332.11 ft<sup>2</sup>  
 Volume: ..... 7,907 G

### Venetian



Width: ..... I.D. 14' 3" / O.D. 15' 3"  
 Length: ..... I.D. 26' 10" / O.D. 27' 10"  
 Depth: ..... 3' 8" - 5' 4"  
 Area ..... 311 ft<sup>2</sup>  
 Volume: ..... 8,787 G

### Pompano Beach





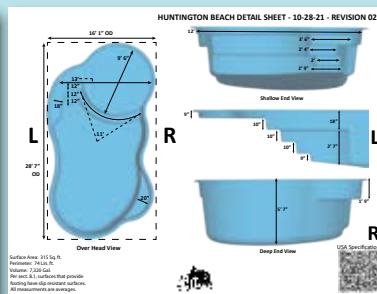
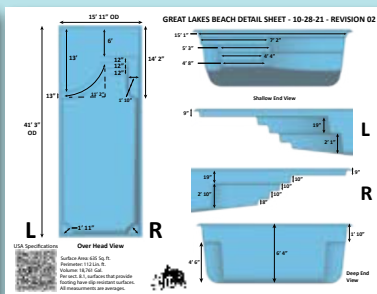
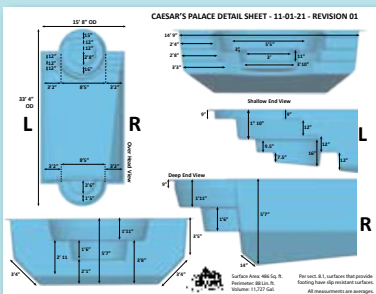

Width: ..... I.D. 12' 10" / O.D. 13' 10"  
 Length: ..... I.D. 28' 9" / O.D. 29' 9"  
 Depth: ..... 3' 5" - 5' 5"  
 Area ..... 308 ft<sup>2</sup>  
 Volume: ..... 8,832 G

Check Out Our Pool Detail Drawings  
<https://sanjuanpools.com/detail-sheets>



# San Juan Fiberglass Pool & Spa Models

<p><b>Desert Falls</b></p>  <p>Width: ..... I.D. 12' 10" / O.D. 14'            Length: ..... I.D. 29' 1" / O.D. 30' 1"            Depth: ..... 3'-6"            Area ..... 299.48 ft<sup>2</sup>            Volume: ..... 8,397 G</p>	<p><b>Desert Springs</b></p>  <p>Width: ..... I.D. 12' 10" / O.D. 14'            Length: ..... I.D. 29' 1" / O.D. 30' 1"            Depth: ..... 3'-6"            Area ..... 299.48 ft<sup>2</sup>            Volume: ..... 7,120 G</p>	<p><b>Sandcastle</b></p>  <p>Width: ..... I.D. 13' 1" / O.D. 14' 1"            Length: ..... I.D. 28' 7" / O.D. 27' 7"            Depth: ..... 3' 3" - 5' 4"            Area ..... 273.6 ft<sup>2</sup>            Volume: ..... 7,271 G</p> <p style="writing-mode: vertical-rl; transform: rotate(180deg);">* West Coast Factory Only</p>	<p><b>Seaside</b></p>  <p>Width: ..... I.D. 10' 10" / O.D. 11' 11"            Length: ..... I.D. 26' 10" / O.D. 27' 10"            Depth: ..... 3' 6" - 6'            Area ..... 241 ft<sup>2</sup>            Volume: ..... 7,070 G</p>
<p><b>Catalina</b></p>  <p>Width: ..... I.D. 11' 2" / O.D. 12' 2"            Length: ..... I.D. 24' 9" / O.D. 25' 9"            Depth: ..... 3' 7" - 5' 7"            Area ..... 218.5 ft<sup>2</sup>            Volume: ..... 6,500 G</p>	<p><b>Lelani</b></p>  <p>Width: ..... I.D. 11' 6" / O.D. 12' 6"            Length: ..... I.D. 24' / O.D. 25'            Depth: ..... 3' 8" - 6' 1"            Area ..... 221.86 ft<sup>2</sup>            Volume: ..... 6,571 G</p>	<p><b>Mandalay Bay</b></p>  <p>Width: ..... I.D. 10' 8" / O.D. 11' 8"            Length: ..... I.D. 24' 1" / O.D. 25' 1"            Depth: ..... 3' 2" - 5' 7"            Area ..... 203 ft<sup>2</sup>            Volume: ..... 5,000 G</p>	<p><b>Cocoa Beach</b></p>  <p>Width: ..... I.D. 10' 8" / O.D. 11' 7"            Length: ..... I.D. 22' 9" / O.D. 23' 8"            Depth: ..... 3' 7" - 5' 6"            Area ..... 193 ft<sup>2</sup>            Volume: ..... 5,273 G</p>
<p><b>Sundial</b></p>  <p>Width: ..... I.D. 10' 9" / O.D. 11' 9"            Length: ..... I.D. 22' 9" / O.D. 23' 9"            Depth: ..... 3' 6" - 5' 7"            Area ..... 193.3 ft<sup>2</sup>            Volume: ..... 5,146 G</p>	<p><b>Ariella</b></p>  <p>Width: ..... I.D. 11' 7" / O.D. 12' 7"            Length: ..... I.D. 20' 1" / O.D. 21' 1"            Depth: ..... 3' 4" - 4' 10"            Area ..... 189 ft<sup>2</sup>            Volume: ..... 4,794 G</p>	<p><b>Palm Beach</b></p>  <p>Width: ..... I.D. 9' 5" / O.D. 10' 5"            Length: ..... I.D. 20' 10" / O.D. 21' 10"            Depth: ..... 3" - 4' 11"            Area ..... 157 ft<sup>2</sup>            Volume: ..... 4,000 G</p>	<p><b>Crystal Beach</b></p>  <p>Width: ..... I.D. 12' 8" / O.D. 13' 8"            Length: ..... I.D. 16' 4" / O.D. 17' 4"            Depth: ..... 3' 7" - 5' 2"            Area ..... 152 ft<sup>2</sup>            Volume: ..... 3,426 G</p>
<p><b>Crystal Cove</b></p>  <p>Width: ..... I.D. 10' 11" / O.D. 11' 11"            Length: ..... I.D. 17' 11" / O.D. 18' 11"            Depth: ..... 3' 7" - 5'            Area ..... 144 ft<sup>2</sup>            Volume: ..... 3,500 G</p>	<p><b>Crystal Springs</b></p>  <p>Width: ..... I.D. 10' 11" / O.D. 11' 11"            Length: ..... I.D. 16' 2" / O.D. 17' 2"            Depth: ..... 4' 2" - 5'            Area ..... 118 ft<sup>2</sup>            Volume: ..... 2,600 G</p>	<p><b>Paradise</b></p>  <p>Width: ..... I.D. 10' 11" / O.D. 11' 11"            Length: ..... I.D. 15' 9" / O.D. 16' 9"            Depth: ..... 4' 6"            Area ..... 108 ft<sup>2</sup>            Volume: ..... 2,950 G</p>	<p><b>Ft Myers</b></p>  <p>Width: ..... I.D. 7' 2" / O.D. 8' 2"            Length: ..... I.D. 15' 2" / O.D. 16' 2"            Depth: ..... 3' 11"            Area ..... 95.25 ft<sup>2</sup>            Volume: ..... 2,150 G</p>



# San Juan Fiberglass Pool & Spa Models



**Margarita Beach**  
 Width: ..... I.D. 9'1" / O.D. 10'  
 Length: ..... I.D. 12'3" / O.D. 13'1"  
 Depth: ..... 3'11"  
 Area ..... 111.27 ft<sup>2</sup>  
 Volume: ..... 1,551 G



**Vancouver**  
 Width: ..... I.D. 10'1" / O.D. 11'4"  
 Length: ..... I.D. 17'1" / O.D. 18'3"  
 Depth: ..... 3'8"  
 Area ..... 119 ft<sup>2</sup>  
 Volume: ..... 2,332 G



**Montreal**  
 Width: ..... I.D. 10'10" / O.D. 11'10"  
 Length: ..... I.D. 14'6" / O.D. 15'6"  
 Depth: ..... 3'9"  
 Area ..... 102.9 ft<sup>2</sup>  
 Volume: ..... 2,026 G



**Sydney**  
 Width: ..... I.D. 9'11" / O.D. 11'2"  
 Length: ..... I.D. 15'3" / O.D. 16'8"  
 Depth: ..... 3'4"  
 Area ..... 147 ft<sup>2</sup>  
 Volume: ..... 2,105 G



**Peninsula**  
 Width: ..... I.D. 7'6" / O.D. 8'4"  
 Length: ..... I.D. 9'10" / O.D. 10'10"  
 Depth: ..... 3'2"  
 Area ..... 75.2 ft<sup>2</sup>  
 Volume: ..... 1,171 G



**Charlotte Spa**  
 Width: ..... I.D. 7' / O.D. 8'  
 Length: ..... I.D. 11' / O.D. 12'  
 Depth: ..... 3'2"  
 Area ..... 60.31 ft<sup>2</sup>  
 Volume: ..... 862 G



**Margarita Spa**  
 Width: ..... I.D. 8'11" / O.D. 9'11"  
 Length: ..... I.D. 6'7" / O.D. 9'4"  
 Depth: ..... 3'11"  
 Area ..... 60 ft<sup>2</sup>  
 Volume: ..... 1,050 G



**Sarasota Spa**  
 Width: ..... I.D. 8'1" / O.D. 8'10"  
 Length: ..... I.D. 8'1" / O.D. 8'10"  
 Depth: ..... 3'5"  
 Area ..... 53 ft<sup>2</sup>  
 Volume: ..... 861 G



**Diamond Spa**  
 Width: ..... I.D. 7' / O.D. 8'  
 Length: ..... I.D. 7' / O.D. 8'  
 Depth: ..... 2'11"  
 Area ..... 44 ft<sup>2</sup>  
 Volume: ..... 630 G



**Royale Spa**  
 Width: ..... I.D. 6' / O.D. 7'  
 Length: ..... I.D. 9'3" / O.D. 10'3"  
 Depth: ..... 2'10" - 3'2"  
 Area ..... 43.3 ft<sup>2</sup>  
 Volume: ..... 714 G



**Isle Spa**  
 Width: ..... I.D. 7' / O.D. 8'  
 Length: ..... I.D. 7' / O.D. 8'  
 Depth: ..... 3'  
 Area ..... 40.4 ft<sup>2</sup>  
 Volume: ..... 600 G



**Lido Spa**  
 Width: ..... I.D. 5'11" / O.D. 6'11"  
 Length: ..... I.D. 6'1" / O.D. 7'1"  
 Depth: ..... 3'  
 Area ..... 36 ft<sup>2</sup>  
 Volume: ..... 543 G



**Scottsdale Spa**  
 Width: ..... I.D. 5'11" / O.D. 6'11"  
 Length: ..... I.D. 6'1" / O.D. 7'1"  
 Depth: ..... 3'  
 Area ..... 36 ft<sup>2</sup>  
 Volume: ..... 543 G



**Haven Spa**  
 Width: ..... I.D. 5'10" / O.D. 6'10"  
 Length: ..... I.D. 5'10" / O.D. 6'10"  
 Depth: ..... 3'  
 Area ..... 28.18 ft<sup>2</sup>  
 Volume: ..... 427.37 G



**Grande Spa**  
 Width: ..... I.D. 7'3" / O.D. 8'  
 Length: ..... I.D. 7'3" / O.D. 8'  
 Depth: ..... 3'2"  
 Area ..... 40.59 ft<sup>2</sup>  
 Volume: ..... 405 G



**Cove Spa**  
 Width: ..... I.D. 5'1" / O.D. 6'1"  
 Length: ..... I.D. 5'1" / O.D. 6'1"  
 Depth: ..... 2'11"  
 Area ..... 25.84 ft<sup>2</sup>  
 Volume: ..... 359 G



**Fun Deck**  
 Width: ..... I.D. 13' / O.D. 14'  
 Length: ..... I.D. 15' / O.D. 16'  
 Depth: ..... 9" - 3'3"  
 Area ..... 208.75 ft<sup>2</sup>  
 Volume: ..... 2,100 G



**Tanning Ledge - Freeform**  
 Width: ..... I.D. 11' / O.D. 12'  
 Length: ..... I.D. 16'1" / O.D. 17'1"  
 Depth: ..... 1'6"  
 Area ..... 118 ft<sup>2</sup>  
 Volume: ..... 1,309 G



**Tanning Ledge - Round**  
 Width: ..... I.D. 6'7" / O.D. 7'7"  
 Length: ..... I.D. 10'6" / O.D. 11'6"  
 Depth: ..... 12"  
 Area ..... 50.9 ft<sup>2</sup>  
 Volume: ..... 333.6 G



**Scottsdale Tanning Ledge**  
 Width: ..... I.D. 7'3" / O.D. 8'3"  
 Length: ..... I.D. 11' / O.D. 12'  
 Depth: ..... 12"  
 Area ..... 62.5 ft<sup>2</sup>  
 Volume: ..... 100 G

\* West Coast Factory Only

\* Additional cross-country freight

# Will A San Juan Fiberglass Pool Fit In My Backyard?

Will Your favorite San Juan Fiberglass Pool fit in Your backyard? Let's find out the easy way with San Juan Pools' "canibuild" software.

Just go to SanJuanPools.com and key in your address, pick your favorite pool and place in your yard.

It's that simple!!

<https://sanjuanpools.com>



LOOK  
SCAN ME!



Can I add a San Juan Fiberglass Swimming Pool to my property?  
With our visualization tools you can see how it looks in your backyard.

Powered By

**Step One**  
Type in Your Address

**Step Two**  
Select Your Pool Model

**Step Three**  
Drag and Position in Your Property

